

TOP VIEW

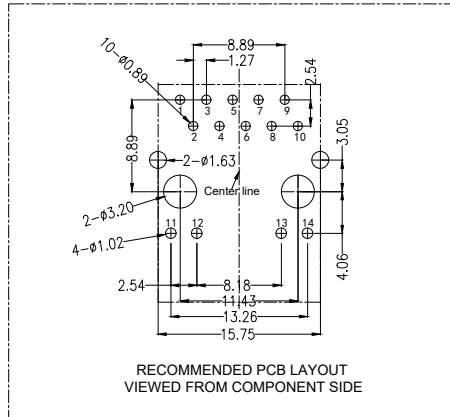

MATERIAL:

HOUSING: PBT,UL94V-0,BLACK.
 TERMINALS BRACKET: PBT,UL94V-0,BLACK.
 SHIELD: BRASS,T=0.20MM,NICKEL PLATING ON ALL AREA.
 TERMINAL: PHOSPHOR BRONZE,T=0.35MM,
 6U" GOLD PLATING ON CONTACT AREA.

MECHANICAL:

DURABILITY: 750 CYCLES MIN.
 MATING FORCE: 23N MAX.
 OPERATING TEMPERATURE: -40°C~+85°C.
 STORAGE TEMPERATURE: -40°C~+85°C.
 ALL CRITICAL DIMENSIONS WITH "*"

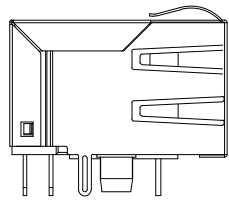

LEFT SIDE VIEW

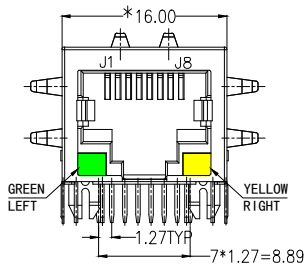

FRONT VIEW

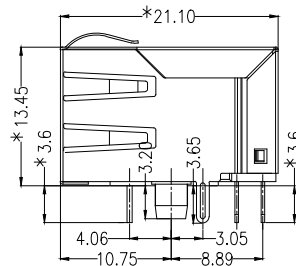

RIGHT SIDE VIEW

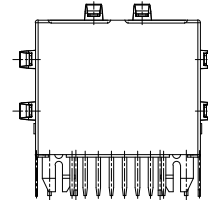

BACK VIEW

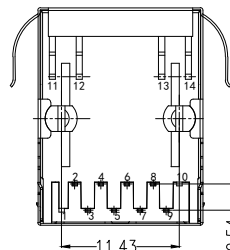

BOTTOM VIEW

Ordering Information

HC 6* * * ** A - M*** - A

Type	LED Color	EMI	Ports	产品序号
61-卧式插件	0-蓝灯	0-无弹	1-4口	
62-立式插件	1-蓝灯 (左绿右黄)	1-有弹	01-1口	
63-立式贴片	2-蓝灯 (左绿右黄)	2-有弹	02-2口	
64-立式贴片	3-蓝灯 (左绿右黄)	3-有弹	03-3口	
	4-蓝灯 (左绿右黄)	4-有弹	04-4口	
	5-蓝灯 (左绿右黄)	5-有弹	05-5口	
	6-蓝灯 (左绿右黄)	6-有弹	06-6口	
	7-蓝灯 (左绿右黄)	7-有弹	07-7口	
	8-蓝灯 (左绿右黄)	8-有弹	08-8口	

			GENERAL TOLERANCE		制图 DRAWING		深圳市华灿天禄电子有限公司 ShenzhenhuacantianluELECTRONICS CO.,LTD					
			DIM	TOL	审核 CHECK		产品名称 TITLE	网络插座 (卧插 带灯带弹 左绿 右黄 TAB-DOWN 1X1 1000BASE)		版本 REV.	A	
			X.X	±0.30	批准 APPROVAL		产品料号 PART NO.	HC612701A-M420-A		单位 UNITS	mm	
			X.XX	±0.20	比例 SCALE							
			X.XXX	±0.10	投影 Projection							
序号 No.	变更内容 MODIFY CONTENT	日期 MODIFY DATE	Angle	±3.0°	材料 MATERIAL							
页次 SHEET												1/4

RECOMMENDED PANEL CUTOUT (REFERENCE ONLY):

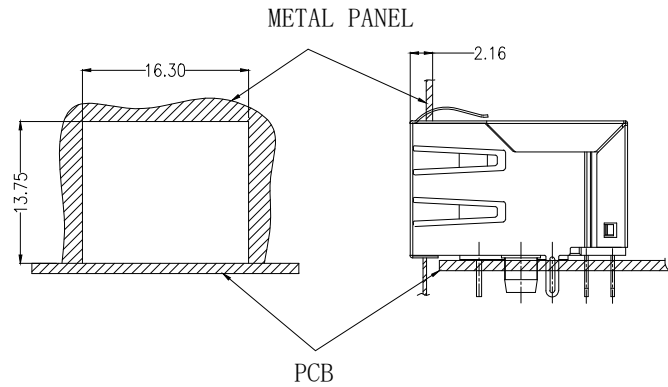

UNIT: MM / INCH
 TOLERANCES: $\pm 0.10 / 0.004$
 REFERENCE ONLY

KEEP-OUT AREA (COMPONENT SIDE VIEW):

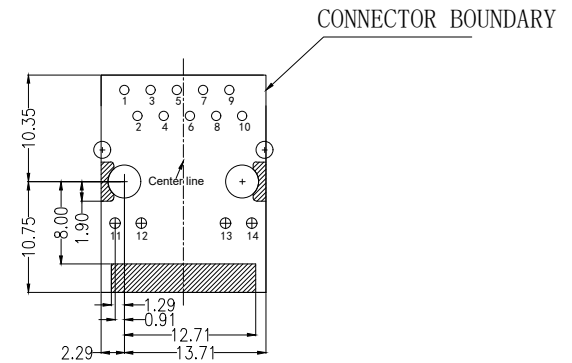

PLUG-IN SIDE

UNIT: MM / INCH
 TOLERANCES: $\pm 0.10 / 0.004$

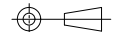
			GENERAL TOLERANCE		制图 DRAWING	 深圳市华灿天禄电子有限公司 ShenzhenhuacantianluELECTRONICS CO.,LTD				
			DIM	TOL	审核 CHECK	产品名称 TITLE		网络插座 (卧插 带灯带弹 左绿 右黄 TAB-DOWN 1X1 1000BASE)	版本 REV.	A
			X.X	± 0.30	批准 APPROVAL	产品料号 PART NO.		HC612701A-M420-A	单位 UNITS	mm
1	初版发行		X.XX	± 0.20	比例 SCALE	材料 MATERIAL			页次 SHEET	2/4
序号 No.	变更内容 MODIFY CONTENT	日期 MODIFY DATE	X.XXX	± 0.10	投影 Projection					
			Angle	$\pm 3.0^\circ$						

PCB SIDE TO PHY

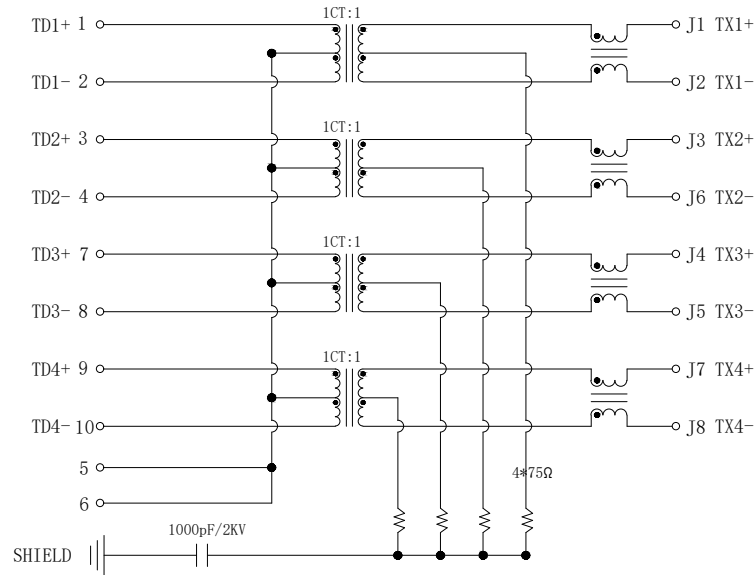

CABLE SIDE

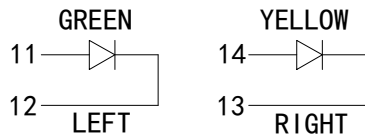

Electrical:

- Turn ratio: 1~2: J1~J2=1CT:1CT(±2%).
3~4: J3~J6=1CT:1CT(±2%).
7~8: J4~J5=1CT:1CT(±2%).
9~10: J7~J8=1CT:1CT(±2%).
- OCL: 350uH Min. at 100KHz 100mV 8mA DC.
- Insertion Loss: -1.0 dB Max 1~100MHz.
- Return loss: -18dB Min 1~30MHz;
-14dB Min 30~60MHz.
-12dB Min 60~80MHz.
-10dB Min 80~100MHz.
- Cross talk: -40dB Min 1~30MHz;
-35dB Min 30~60MHz;
-30dB Min 60~100MHz;
- CMR: -30dB Min 1~100MHz;
- Hi-Pot: 2250V DC 6S 1mA PRI TO SEC

LED Specification

Standard LED Color	LED Wavelength	Foward(A)	Foward(V)
Green	568nm	20mA	1.85-2.45V
Yellow	585nm	20mA	1.7-2.2V

		GENREL TOLERANCE		制图 DRAWING	深圳市华灿天禄电子有限公司 ShenzhenhuacantianluELECTRONICS CO.,LTD			
		DIM	TOL	审核 CHECK	产品名称 TITLE	网络插座 (卧插 带灯带弹 左绿 右黄 TAB-DOWN 1X1 1000BASE)	版本 REV.	A
1		初版发行		批准 APPROVAL	产品料号 PART NO.	HC612701A-M420-A	单位 UNITS	mm
序号 No.	变更内容 MODIFY CONTENT	日期 MODIFY DATE	Angle	±3.0°	投影 Projection	材料 MATERIAL	页次 SHEET	3/4

PROFILE OF WAVE SOLDER

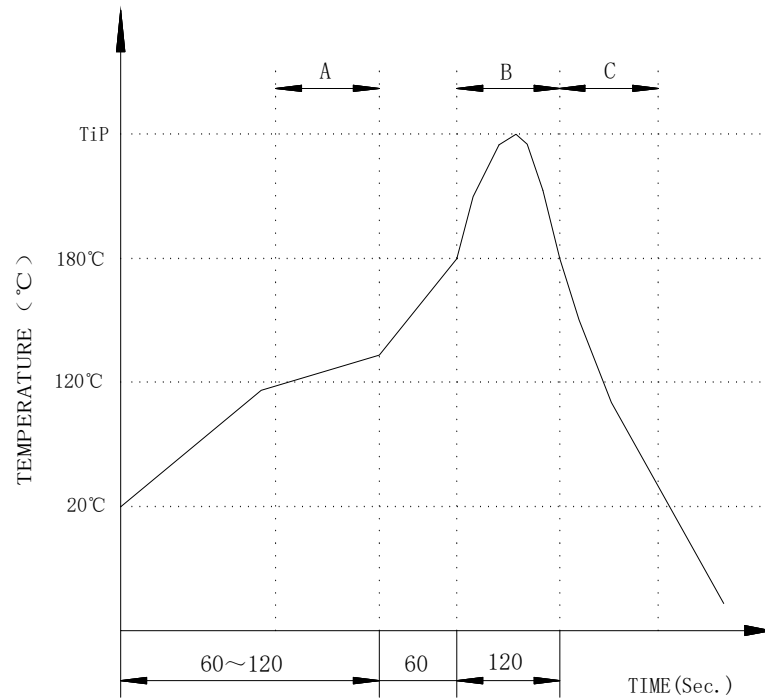

A.Preheating B.Soldering C.Gradual Cooling
 Tip temperature:260±5°C.
 Tip temperature time:5Sec Max.
 Tip melting point of Sn96.5/Ag3/Cu0.5:217°C.

Remarks: after wave soldering, the plastic positioning columns of the product which under the PCB will be slightly melted, but it won't affect its function.

			GENEAL TOLERANCE	制图 DRAWING	 深圳市华灿天禄电子有限公司 ShenzhenhuacantianluELECTRONICS CO.,LTD			
			DIM TOL	审核 CHECK	产品名称 TITLE	网络插座 (卧插 带灯带弹 左绿 右黄 TAB-DOWN 1X1 1000BASE)	版本 REV.	A
			X.X ±0.30	批准 APPROVAL	产品料号 PART NO.	HC612701A-M420-A	单位 UNITS	mm
1	初版发行		X.XX ±0.20	比例 SCALE	材料 MATERIAL		页次 SHEET	4/4
序号 No.	变更内容 MODIFY CONTENT	日期 MODIFY DATE	X.XXX ±0.10	投影 Projection				
			Angle ±3.0°	