

TOP VIEW

*32.50

MATERIAL:

HOUSING: PBT,UL94V-0,BLACK.
 TERMINALS BRACKET: PBT,UL94V-0,BLACK.
 SHIELD: C2680,T=0.20MM,NICKEL PLATING ON ALL AREA.
 TERMINAL: PHOSPHOR BRONZE C5210,T=0.35MM,
 6U" GOLD PLATING ON CONTACT AREA.

MECHANICAL:

DURABILITY: 750 CYCLES MIN.
 MATING FORCE: 23N MAX.
 OPERATING TEMPERATURE: -40°C~+85°C.
 STORAGE TEMPERATURE: -40°C~+85°C.
 ALL CRITICAL DIMENSIONS WITH "*"

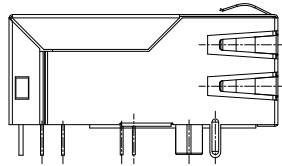

LEFT SIDE VIEW

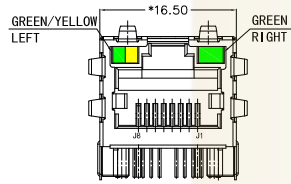

FRONT VIEW

GREEN/YELLOW
LEFT

GREEN
RIGHT

*16.50

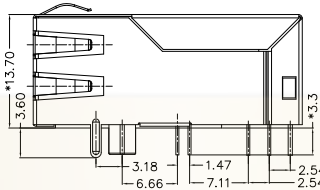

RIGHT SIDE VIEW

*13.70

3.18

6.66

1.47

7.11

2.54

2.54

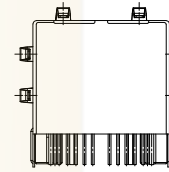

BACK VIEW

*3.3

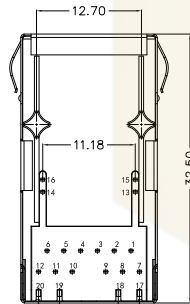

BOTTOM VIEW

12.70

32.50

11.18

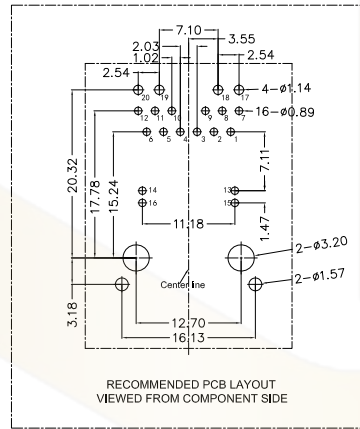

RECOMMENDED PCB LAYOUT
 VIEWED FROM COMPONENT SIDE

2.03

1.02

7.10

3.55

2.54

4-φ1.14

16-φ0.89

2.54

φ14

φ16

11.18

1.47

2-φ3.20

2-φ1.57

3.18

20.32

17.78

15.24

12.70

16.13

Centerline

Ordering Information

HC 6* * * ** A - M*** - A

Type	LED Color	EMI	Ports	产品序号
▶ 卧式插板	▶ 蓝绿	▶ 无	▶ 1x1	
▶ 立式插板	▶ 蓝绿 (带黄绿)	▶ 有	▶ 1x1	
▶ 立式插板	▶ 蓝绿 (带黄绿)	▶ 有	▶ 1x1	
▶ 立式插板	▶ 蓝绿 (带黄绿)	▶ 有	▶ 1x1	
▶ 立式插板	▶ 蓝绿 (带黄绿)	▶ 有	▶ 1x1	
▶ 立式插板	▶ 蓝绿 (带黄绿)	▶ 有	▶ 1x1	
▶ 立式插板	▶ 蓝绿 (带黄绿)	▶ 有	▶ 1x1	
▶ 立式插板	▶ 蓝绿 (带黄绿)	▶ 有	▶ 1x1	
▶ 立式插板	▶ 蓝绿 (带黄绿)	▶ 有	▶ 1x1	
▶ 立式插板	▶ 蓝绿 (带黄绿)	▶ 有	▶ 1x1	

			GENERL TOLERANCE	制图	深圳市华灿天禄电子有限公司			
			DIM TOL	审核	ShenzhenhuacantianluELECTRONICS CO., LTD			
			X.X ±0.30	批准	产品名称	网络插座 (卧插 带灯带弹 左绿+黄	版本	A
			X.XX ±0.20	检查	TITLE	右绿 TAB-UP 1x1 10/100/1000BASE POE+)	REV.	
1	初版发行		X.XXX ±0.10	投影	产品料号	HC618701A-M410-A	单位	mm
序号	变更内容	日期	Angle ±3.0°	投影	PART NO.		页次	1/4
No.	MODIFY CONTENT	MODIFY DATE		Projection	MATERIAL		SHEET	

Suggested Panel Opening:

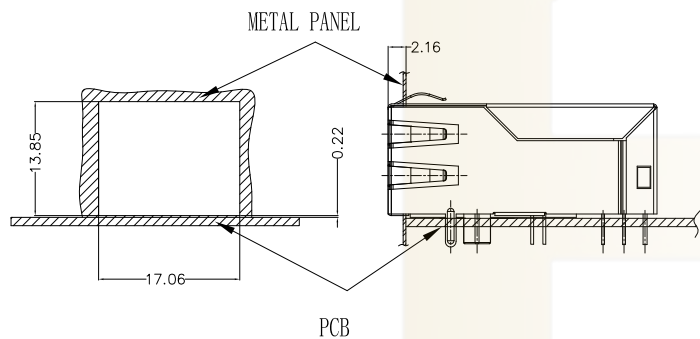

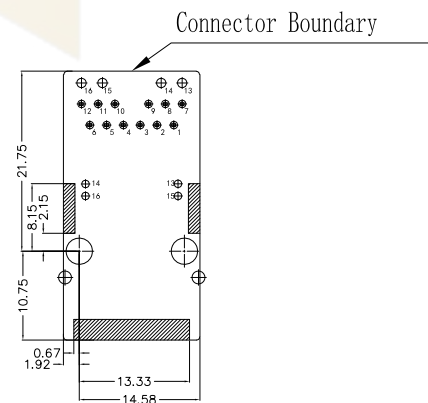

UNIT: mm / inch
Tolerances: $\pm 0.10 / 0.004$

Keep-Out Area (Component Side View):



Plug-in side

UNIT: mm / inch
Tolerances: $\pm 0.10 / 0.004$

			GENERAL TOLERANCE	制图 DRAWING	 深圳市华灿天禄电子有限公司 ShenzhenhuacantianluELECTRONICS CO., LTD				
			DIM TOL	审核 CHECK		产品名称 TITLE	网络插座 (卧插 带灯带弹 左绿+黄 右绿 TAB-UP 1x1 10/100/1000BASE POE+)	版本 REV.	A
			X.X ± 0.30	批准 APPROVAL		产品料号 PART NO.	HC618701A-M410-A	单位 UNITS	mm
1	初版发行		X.XX ± 0.20	比例 SCALE		材料 MATERIAL		页次 SHEET	2/4
序号 No.	变更内容 MODIFY CONTENT	日期 MODIFY DATE	X.XXX ± 0.10	投影 Projection					
			Angle $\pm 3.0^\circ$						

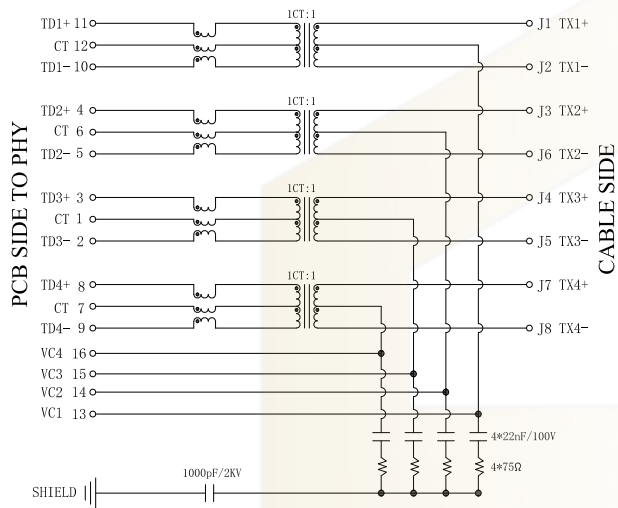

Electrical:

- Turn ratio: 11~10:J1~J2=1CT:1CT(±2%).
4~5:J3~J6=1CT:1CT(±2%).
3~2:J4~J5=1CT:1CT(±2%).
8~9:J7~J8=1CT:1CT(±2%).
- OCL:350uH Min.@ 100KHz 100mV
RMS(4Channel) 15mA DC BIAS.
- Insertion Loss: -1.0 dB Max 1~100MHz.
- Return loss: -18dB Min 1~30MHz;
-14dB Min 30~60MHz.
-12dB Min 60~80MHz.
-10dB Min 80~100MHz.
- Cross talk: -40dB Min 1~30MHz;
-35dB Min 30~60MHz;
-30dB Min 60~100MHz;
- CMR: -30B Min 1~100MHz;
- Hi-Pot:2250V DC 6S 1mA PRI TO SEC
To IEEE802.3bt for PSE or PD applications.
- 100% of production tested to comply with IEEE 802.3 isolation requirements balanced DC line current 720mA max. 57V DC continuous.

LED Specification

Standard LED Color	LED Wavelength	Foward(A)	Foward(V)
Green	568nm	20mA	1.85-2.45V
Yellow	585nm	20mA	1.7-2.2V

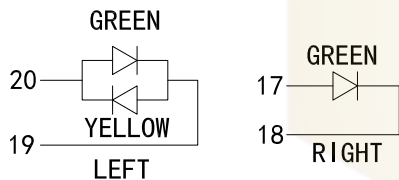

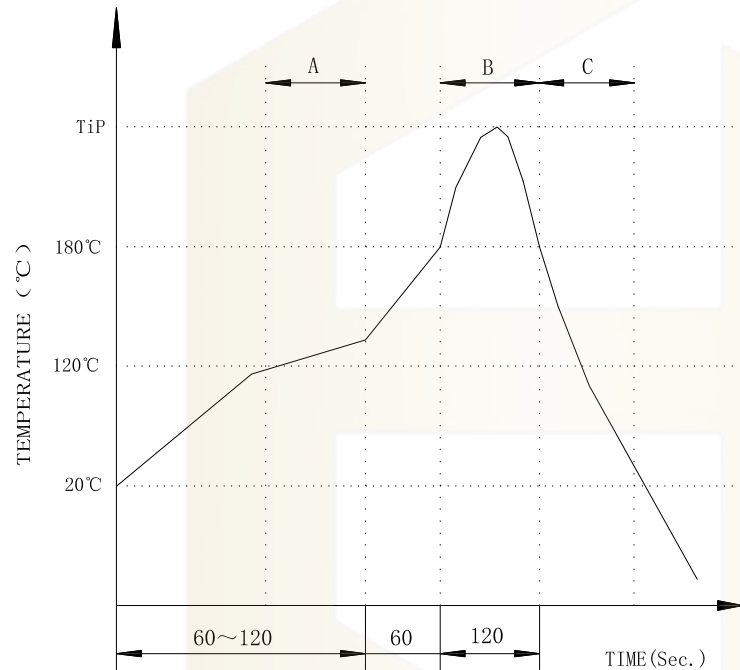

			GENERAL TOLERANCE	制图 DRAWING	深圳市华灿天禄电子有限公司 ShenzhenhuacantianluELECTRONICS CO.,LTD				
			DIM TOL	审核 CHECK	产品名称 TITLE		网络插座 (卧插 带灯带弹 左绿+黄 右绿 TAB-UP 1x1 10/100/1000BASE POE+)	版本 REV.	A
			X.X ±0.30	批准 APPROVAL	产品料号 PART NO.		HC618701A-M410-A	单位 UNITS	mm
			X.XX ±0.20	投影 Projection	材料 MATERIAL			页次 SHEET	3/4
			X.XXX ±0.10						
序号 No.	变更内容 MODIFY CONTENT	日期 MODIFY DATE	Angle ±3.0°						

PROFILE OF WAVE SOLDER



A.Preheating B.Soldering C.Gradual Cooling
 Tip temperature:260±5°C.
 Tip temperature time:5Sec Max.
 Tip melting point of Sn96.5/Ag3/Cu0.5:217°C.

Remarks: after wave soldering, the plastic positioning columns of the product which under the PCB will be slightly melted, but it won't affect its function.

			GENERAL TOLERANCE	制图 DRAWING	 深圳市华灿天禄电子有限公司 ShenzhenhuacantianluELECTRONICS CO., LTD				
			DIM TOL	审核 CHECK					
			X.X ±0.30	批准 APPROVAL		产品名称 TITLE	网络插座 (卧插 带灯带弹 左绿+黄 右绿 TAB-UP 1x1 10/100/1000BASE POE+)	版本 REV.	A
1	初版发行		X.XX ±0.20	比例 SCALE		产品料号 PART NO.	HC618701A-M410-A	单位 UNITS	mm
序号 No.	变更内容 MODIFY CONTENT	日期 MODIFY DATE	X.XXX ±0.10	投影 Projection		材料 MATERIAL		页次 SHEET	4/4
			Angle ±3.0°						