

MATERIAL:

HOUSING: PBT,UL94V-0,BLACK.
 TERMINALS BRACKET: PBT,UL94V-0,BLACK.
 SHIELD: C2680,T=0.20MM,NICKEL PLATING ON ALL AREA.
 TERMINAL: PHOSPHOR BRONZE C5210,T=0.35MM,
 6U" GOLD PLATING ON CONTACT AREA.

MECHANICAL:

DURABILITY: 750 CYCLES MIN.
 MATING FORCE: 23N MAX.
 OPERATING TEMPERATURE: -40°C~+85°C.
 STORAGE TEMPERATURE: -40°C~+85°C.
 ALL CRITICAL DIMENSIONS WITH "*"

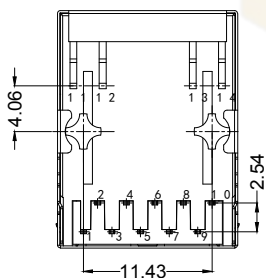
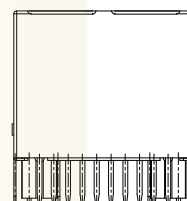
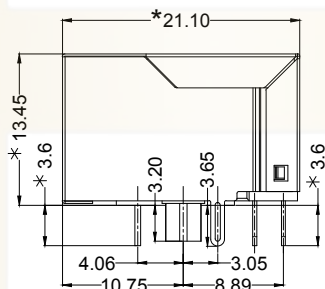
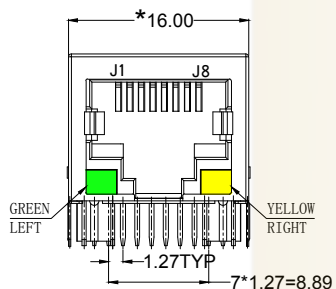
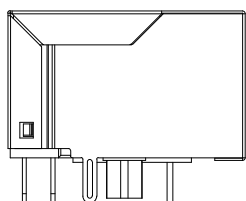
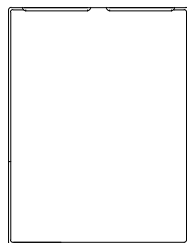

Ordering Information

HC 61 * * ** A - M915 - A

Type LED Color EMI Ports 产品序号
 61-卧式插件 0-无灯 0-无EMI 1-8脚 1-8脚
 62-立式插件 1-带灯 (左黄右绿) 1-无EMI 7-带脚 01-11口
 63-卧式贴片 2-带灯 (左黄右绿) 2-有EMI 02-211
 64-立式贴片 3-带灯 (左黄右绿) 3-有EMI 22-22211
 4-带灯 (左绿右橙)

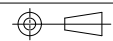
		GENERAL TOLERANCE		制图 DRAWING		 深圳市华灿天禄电子有限公司 ShenzhenuacantianluELECTRONICS CO.,LTD			
		DIM TOL		审核 CHECK					
		X.X ±0.30		批准 APPROVAL		产品名称 TITLE	网络插座 (插件 TAB-DOWN 1X1 10/100/1000BASE)	版本 REV.	A
1		初版发行		X.XX ±0.20		产品料号 PART NO.	HC612601A-M915-A	单位 UNITS	mm
序号 No.		变更内容 MODIFY CONTENT		日期 MODIFY DATE		材料 MATERIAL		页次 SHEET	1/4
		Angle ±3.0°		投影 Projection					

RECOMMENDED PANEL CUTOUT (REFERENCE ONLY) :

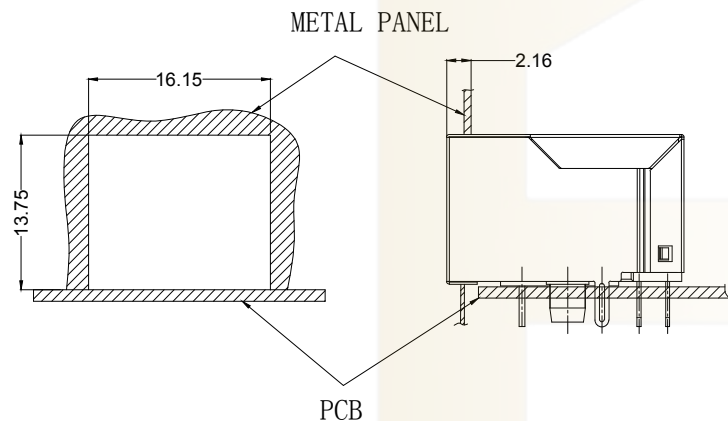

UNIT: MM / INCH
 TOLERANCES: ± 0.10 / 0.004
 REFERENCE ONLY

KEEP-OUT AREA (COMPONENT SIDE VIEW) :

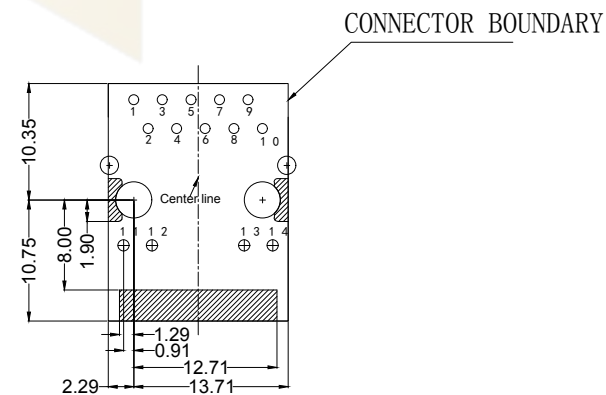

PLUG-IN SIDE

UNIT: MM / INCH
 TOLERANCES: ± 0.10 / 0.004

		GENERAL TOLERANCE		制图 DRAWING	 深圳市华灿天禄电子有限公司 ShenzhenhuacantianluELECTRONICS CO.,LTD			
		DIM	TOL	审核 CHECK				
		X.X	± 0.30	批准 APPROVAL	产品名称 TITLE	网络插座 (插件 TAB-DOWN 1X1 10/100/1000BASE)	版本 REV.	A
1	初版发行	X.XX	± 0.20	比例 SCALE	产品料号 PART NO.	HC612601A-M915-A	单位 UNITS	mm
序号 No.	变更内容 MODIFY CONTENT	日期 MODIFY DATE	Angle $\pm 3.0^\circ$	投影 Projection	材料 MATERIAL		页次 SHEET	2/4

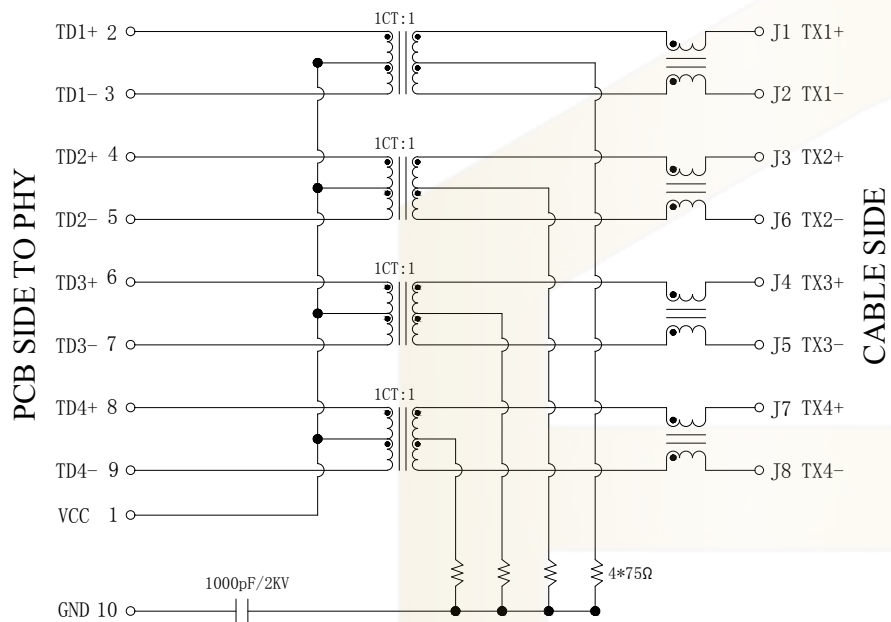

Electrical:

- Turn ratio: 2~3: J1~J2=1CT:1CT(±2%).
4~5: J3~J6=1CT:1CT(±2%).
6~7: J4~J5=1CT:1CT(±2%).
8~9: J7~J8=1CT:1CT(±2%).
- OCL: 350uH Min. at 100KHz 100mV 8mA DC.
- Insertion Loss: -1.0 dB Max 1~100MHz.
- Return loss: -18dB Min 1~30MHz;
-14dB Min 30~60MHz.
-12dB Min 60~80MHz.
-10dB Min 80~100MHz.
- Cross talk: -40dB Min 1~30MHz;
-35dB Min 30~60MHz;
-30dB Min 60~100MHz;
- CMR: -30dB Min 1~100MHz;
- Hi-Pot: 2250V DC 6S 1mA PRI TO SEC

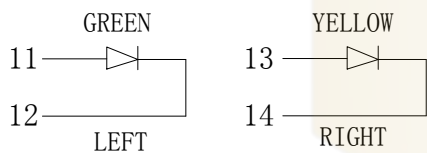

LED Specification

Standard LED Color	LED Wavelength	Foward(A)	Foward(V)
Green	568nm	20mA	1.85-2.45V
Yellow	585nm	20mA	1.7-2.2V

		GENERAL TOLERANCE	制 图 DRAWING	深圳市华灿天禄电子有限公司 ShenzhenhuacantianluELECTRONICS CO., LTD				
		DIM TOL	审 核 CHECK		产品名称 TITLE	网络插座 (插件 TAB-DOWN 1X1 10/100/1000BASE)	版 本 REV.	A
		X.X ±0.30	批 准 APPROVAL		产品料号 PART NO.	HC612601A-M915-A	单 位 UNITS	mm
1	初版发行	X.XX ±0.20	比 例 SCALE		材 料 MATERIAL		页 次 SHEET	3/4
序号 No.	变更内容 MODIFY CONTENT	日期 MODIFY DATE	Angle ±3.0°	投 影 Projection				

PROFILE OF WAVE SOLDER

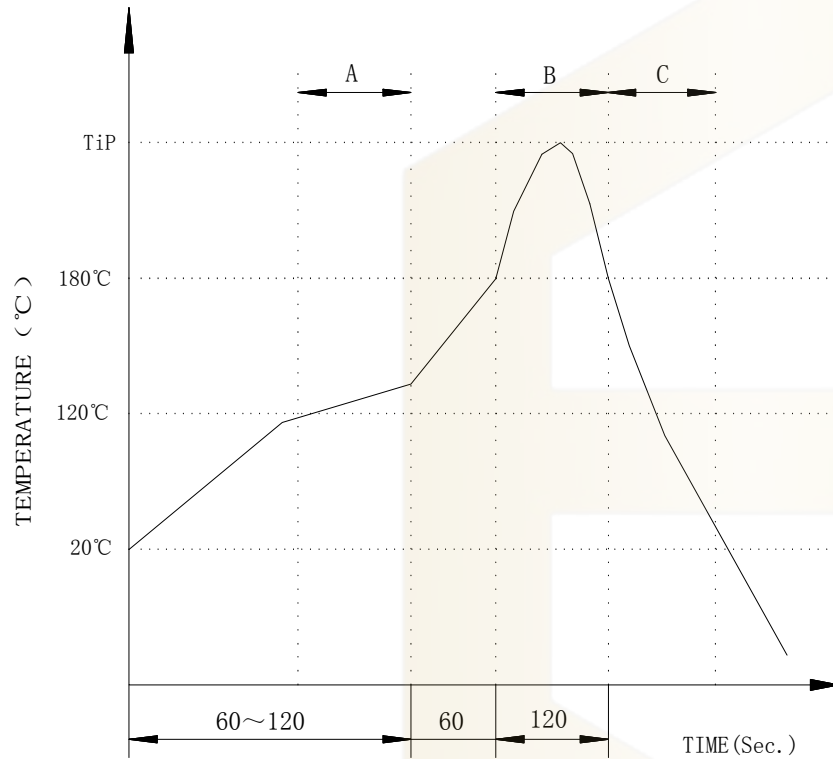

A.Preheating B.Soldering C.Gradual Cooling
 Tip temperature:260±5°C.
 Tip temperature time:5Sec Max.
 Tip melting point of Sn96.5/Ag3/Cu0.5:217°C.

Remarks: after wave soldering, the plastic positioning columns of the product which under the PCB will be slightly melted, but it won't affect its function.

			GENERAL TOLERANCE	制图 DRAWING	 深圳市华灿天禄电子有限公司 ShenzhenhuacantianluELECTRONICS CO.,LTD			
			DIM TOL	审核 CHECK				
			X.X ±0.30	批准 APPROVAL	产品名称 TITLE	网络插座 (插件 TAB-DOWN 1X1 10/100/1000BASE)	版本 REV.	A
1	初版发行		X.XX ±0.20	比例 SCALE	产品料号 PART NO.	HC612601A-M915-A	单位 UNITS	mm
序号 No.	变更内容 MODIFY CONTENT	日期 MODIFY DATE	Angle ±3.0°	投影 Projection	材料 MATERIAL		页次 SHEET	4/4